

TO OPEN:

Open the hook A1 (Fig. 1) on the side of the stroller, and pull the pushchair upwards by the handlebar, until it clicks into place. (Fig. 1)

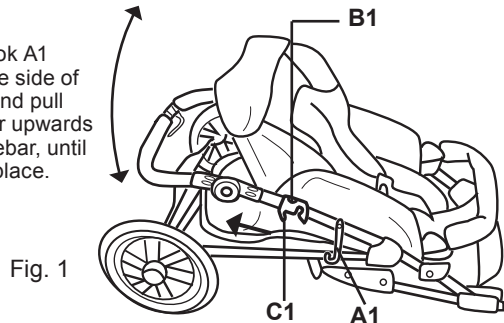

Fig. 1

TO FOLD

The backrest must be in the flat position. Press the button B1 and pull the levers C1 upwards on both sides. Fold the stroller and close the hook A1. (Fig. 1)

TO FIT THE FRONT WHEEL

Push the front wheel with its mounting C2 onto the tubes A2 until the spring buttons B2 engage in the openings of the mounting C2. (Fig. 2)

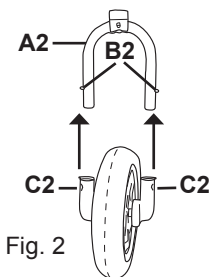

Fig. 2

TO FIT THE REAR WHEELS

TO FIT: Push the rear wheels with the axles A3 onto rear axle mountings B3 until they engage (Fig. 3.1).

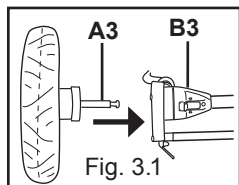

Fig. 3.1

TO REMOVE:

Press the lever C3 and pull the wheel from the axle mounting B3. (Fig. 3.2)

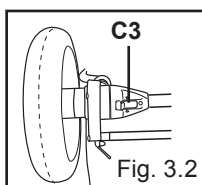

Fig. 3.2

TO FIX AND TO SWIVEL THE FRONT WHEEL

To fix or to swivel the front wheel, push the lever A4 to the right or to the left, respectively. (Fig. 4.1, Fig 4.2)

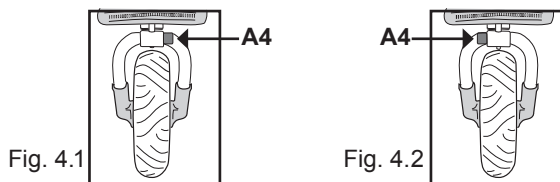

Fig. 4.1

Fig. 4.2

TO FIT THE CANOPY OF THE SEAT

Insert the canopy holders A5 on both sides of the seat canopy (the bigger canopy) into the corresponding openings B5 on the frame tubes. (Fig. 5)
To remove, press the buttons A5 and pull the canopy holders out of the openings B5.

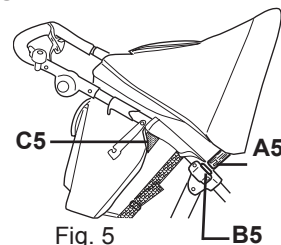

Fig. 5

SAFETY BAR

TO FIT: Press the safety bar fittings A6 onto the frame tubes as shown in Fig. 6.

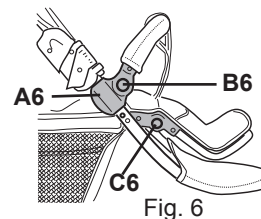

Fig. 6

TO ADJUST: Press the buttons B6 on both sides of the safety bar and adjust it into the desired position. (Fig. 6)

TO ADJUST THE LEG REST

Press the buttons C6 at each side of the legrest joint and adjust to the required position. (Fig. 6)

TO ADJUST THE HANDLEBAR

Press in the buttons A7 at each side of the handlebar (Fig.7) and move it to the required position.

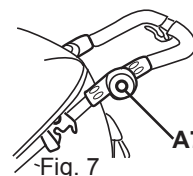

Fig. 7

SAFETY HARNESS

The MARCO Trigon Light has a 5-point safety harness.

TO CLOSE: See Fig. 8.1

TO OPEN: See Fig. 8.2

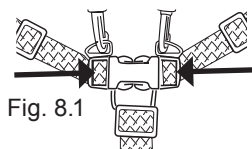

Fig. 8.1

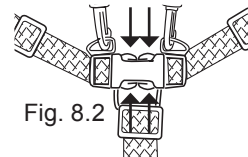

Fig. 8.2

BRAKES

The MARCO Trigon Light is fitted with a handbrake and a „one-touch“ locking brake.

LOCKING BRAKE: To block the wheels push down the brake lever A9. To release the brake push the brake lever A9 upwards. (Fig. 9.1)

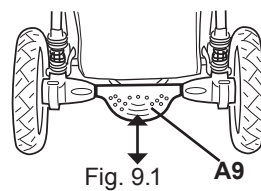

Fig. 9.1

HANDBRAKE: The handbrake B9 is mainly a retarding brake, which acts on the rear wheels. It should, for example, prevent the stroller from becoming too fast on a hill.
To re-tighten the brake cable, the screw E9 must be loosened. After the brake cable is tightened, the tension of the cable can be regulated by turning the ridged screws C9 and D9. (Fig. 9.2, Fig. 9.3)

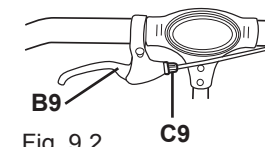

Fig. 9.2

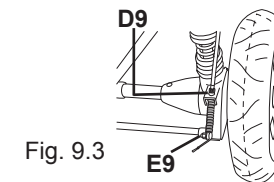

Fig. 9.3

TO ADJUST THE BACKREST

LIE-BACK POSITION: Release the strap A10 to its full length - the backrest will then be in its lowest position. (Fig. 10.1)
UPRIGHT POSITION: Tighten the straps A10 completely and close them with buckles B10 on the backrest. (Fig. 10.2).
TO ADJUST: By lengthening or shortening the straps A10, any required backrest position can be achieved.

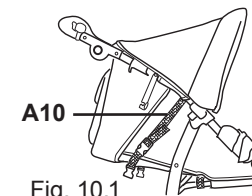

Fig. 10.1

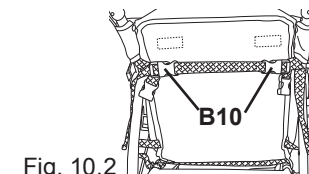

Fig. 10.2

TO REMOVE THE SEAT

Open the press buttons A11 on both sides of the handle bar.

Open the press buttons B11 under the seat on both sides (3 buttons on each side)

The safety harness is attached to the frame tube with metal ring C11. To remove the seat, pull the harness strap through the small opening in the metal ring B11. Open belt buckle D11 under the footrest. Open the velcro E11 and remove the seat fabric from the footrest. (Fig. 11)

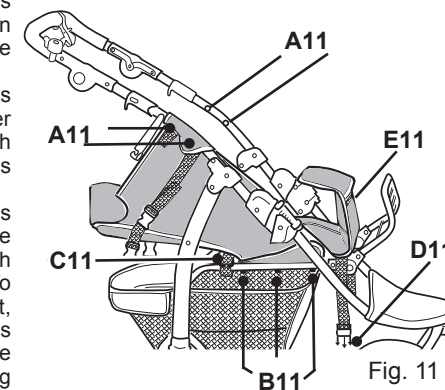

Fig. 11

CARRY COT

Instead of the seat, you can also fit the carry cot on the MARCO Trigon Light frame.

To put up the carry cot, pull the metal bars A12 on the inside of the carry cot floor by the bands into the holders B12. (Fig. 12)

Put the textile unit into the carry cot and pull the elastic over the frame D12 (Fig. 12), so that the canopy holders C12

go through the corresponding openings (Fig. 12, Fig. 13).

Put the mattress into the carry cot.

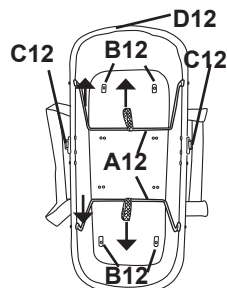

Fig. 12

TO FIT THE CARRY COT CANOPY

Insert the canopy holders on both sides of the carry cot canopy (the smaller canopy) into the corresponding openings C12. (Fig. 12, Fig. 13)

To remove, press the buttons A13 and pull the canopy holders out of the openings C12.

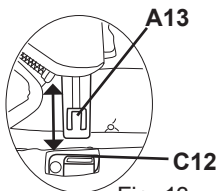

Fig. 13

TO ATTACH THE CARRY COT

Put the holders A14 on the floor of the carry cot onto the frame tube B14. (Fig. 14)

Push the carry cot downwards until you distinctly feel it engage. Close the locks C 14 (Fig. 14) and check if the carry cot is firmly fastened on the frame.

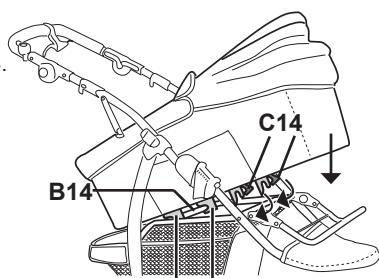

Fig. 14

ACCESSORY

This push chair is equipped with a car seat adapter matching the car seat MARCO Maxxi (Group 0+)
Attention: Car seats of other brands do not fit on the adapter!

TO ATTACH THE CAR SEAT MARCO MAXXI

Press button A15 below the car seat adapter B15 and fold the car seat adapters forward on both sides.

Fig. 15.1, Fig 15.2

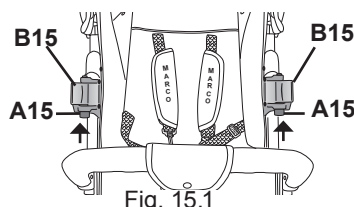

Fig. 15.1

**USER'S INSTRUCTIONS
MARCO TRIGON LIGHT**

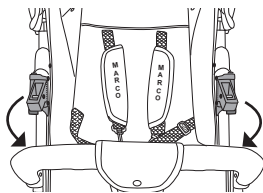

Fig. 15.2

Adjust the bumper bar C15 so that it matches the receptors D15 of the car seat.

In case the bumper bar cannot easily be adjusted, remove the bumper bar turn it round and attach it again.

Press buttons E15 and push the locking devices F15 into the adapters B15 until they engage. (Fig. 15.3)

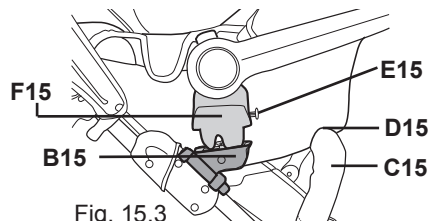

Fig. 15.3

SAFETY
Before putting your child into the MARCO Maxxi car seat, make sure that the car seat is completely attached to the push chair and that all locks are engaged.

MAINTENANCE
The textiles are easily removable and handwashable at 30° C. The frame and the wheels should be wiped with a damp cloth and mild soap. Don't use strong detergents, they could damage plastic. Regularly lubricate the moving parts with silicon oil or silicon spray.

NOTE
This vehicle is intended for children up to a maximum weight of 15kg. The net basket should not be loaded with more than 3 kg. The vehicle is designed to be used by one child only. Spare parts or accessories which are not approved by the manufacturer or dealer may not be used. Periodically check all parts for wear or damage. Do not use stroller if any component is broken or damaged. Please do not make any changes to the stroller that could affect the safety.

WARNINGS
WARNING: It may be dangerous to leave your child unattended.
WARNING: Ensure that all the locking devices are engaged before use.
WARNING: Any load attached to the handle affects the stability of the pram/pushchair.
WARNING: Always use the crotch strap in combination with the waist belts.

English

USER'S INSTRUCTIONS

We congratulate you on your purchase of your jogger with hard carrycot.
The MARCO Trigon Light offers optimal performance + value and is very easy to use.

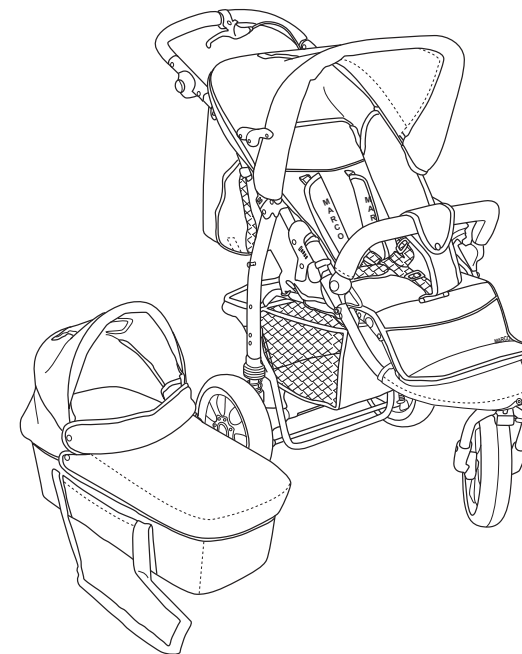

IMPORTANT: Read these instructions carefully before use and keep them for future reference. Your child's safety may be affected if you do not follow these instructions.

MARKETING AND DISTRIBUTION
MARCO HANDELSGESELLSCHAFT M.B.H.
A-5440 GOLLING, AUSTRIA
www.marco4bb.com

© MARCO HANDELSGESELLSCHAFT M.B.H., 2006
A-5440-Golling, Austria