

TO OPEN:

Open the retaining strap **A** on the side of the stroller and push the front axles forwards (Fig. 1). Press down the bottom locking bar **B** carefully with your foot until you can hear it engage (Fig. 1).

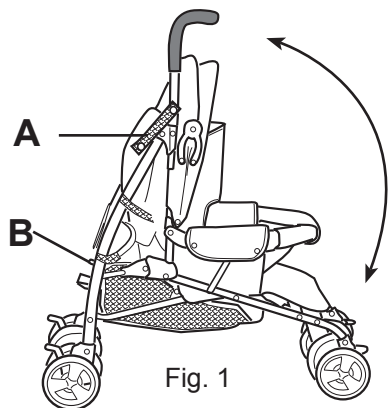

Fig. 1

TO FOLD

Press the bottom locking bar **B** upwards with your foot, push the lever **C1** down with your foot and lift the top lock **C2**. (Fig. 2)
Fold the buggy forwards and together and fasten the retaining strap **A** (Fig. 1)

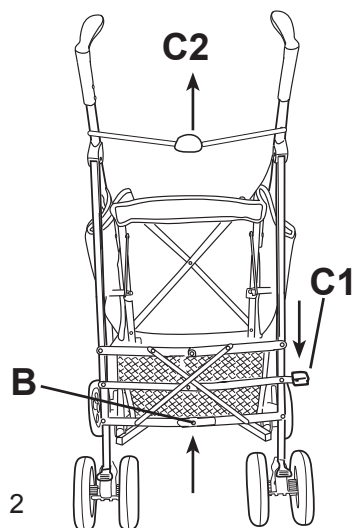

Fig. 2

TO FIT THE FRONT WHEELS

Push the double wheel block **D** onto the upper front wheel housing **E** until it engages. (Fig. 3)

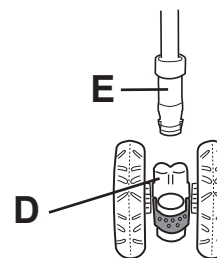

Fig. 3

TO FIX AND TO RELEASE THE BRAKES

TO FIX: Press each brake lever **F** downwards with your foot. Make sure the brakes have engaged. (Fig. 4)

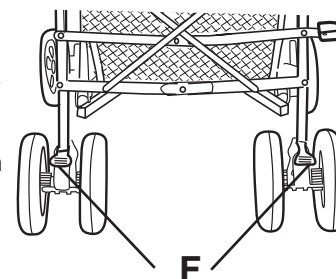

Fig. 4

TO RELEASE: Push both brake levers **F** upwards. (Fig.4)

!	SAFETY	!
<p>Before putting your child in the MARCO Gamma, engage the brakes to make sure it doesn't roll away. Never leave the MARCO Gamma without engaging the brakes.</p>		

TO ADJUST THE LEG REST

Press the two levers **G** under the seat upwards and adjust the legrest to the required position. (Fig. 5)

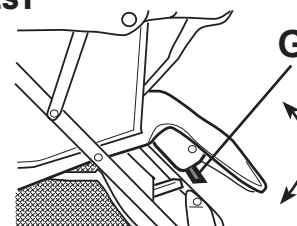

Fig. 5

TO FIX AND TO SWIVEL THE FRONT WHEELS

TO FIX: Turn the front double wheels so that the fixing lever **H** faces the front. To fix the wheels, push the fixing lever **H** upwards until it engages. (Fig. 6)

TO SWIVEL: Press the lever **H** on the double wheel block downwards. (Fig. 6)

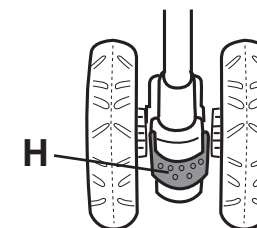

Fig. 6

TO FIT THE CANOPY

Push the canopy fitting hooks **J** onto the handlebar tubes as shown in Fig.7 and fasten the velcros round the frame tube. Press the canopy hinge down on both sides. (Fig. 7)

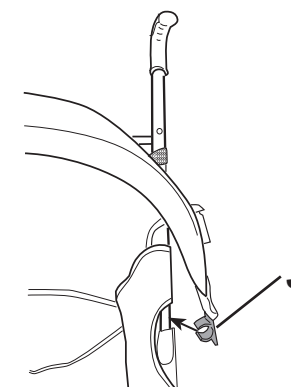

Fig. 7

TO ADJUST THE BACKREST

The backrest has four positions: Fully reclined, plus three adjustable sitting positions. Press both backrest adjustment levers **K** at the same time and release when the desired position has been reached (Fig. 8).

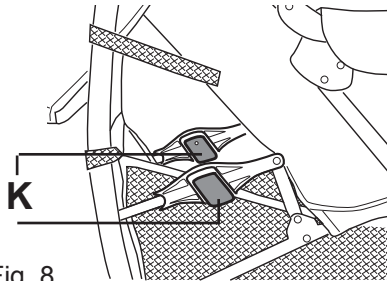

Fig. 8

SAFETY BAR

TO REMOVE: Press the buttons **L** on both sides of the safety bar fitting and remove the safety bar by pulling it forwards. (Fig. 9)
TO FIT: Push the safety bar into the fitting until you hear it engage. (Fig. 9)

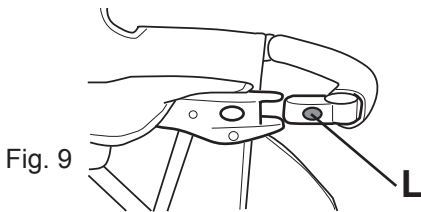

Fig. 9

TO OPEN AND TO FASTEN THE SAFETY BELT

The MARCO Gamma QX has a 5-point safety harness.
TO FASTEN: See Fig. 10.1
TO OPEN: See Fig. 10.2

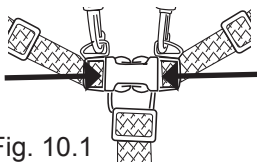

Fig. 10.1

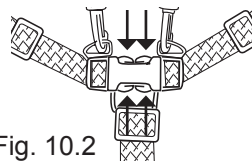

Fig. 10.2

! MAINTENANCE !

The textiles are handwashable at 30° C. The frame should be wiped with a damp cloth and mild soap. Don't use strong detergents, they could damage plastic. Regularly lubricate the moving parts with silicon oil or silicon spray.

! NOTE !

This vehicle is intended for children of at least 6 months, and up to a maximum weight of 15kg. The net basket should not be loaded with more than 3 kg.
The vehicle is designed to be used by one child only.
Spare parts or accessories which are not approved by the manufacturer or dealer may not be used.
All parts of the vehicle should be inspected regularly to ensure that they function properly.

! WARNINGS !

- ▲ This seat is not suitable for children under 6 months.
- ▲ It may be dangerous to leave your child unattended.
- ▲ Ensure that all the locking devices are engaged before use.
- ▲ Any load attached to the handle affects the stability of the pram/pushchair.
- ▲ Always use the safety harness.
- ▲ This product is NOT suitable for jogging or inline skating.

USER'S INSTRUCTIONS

We congratulate you on your purchase of the MARCO Gamma. This pushchair offers optimal performance and value and is very easy to use.

Serial number (on the back of the washing label):
For all inquiries please indicate the serial number.

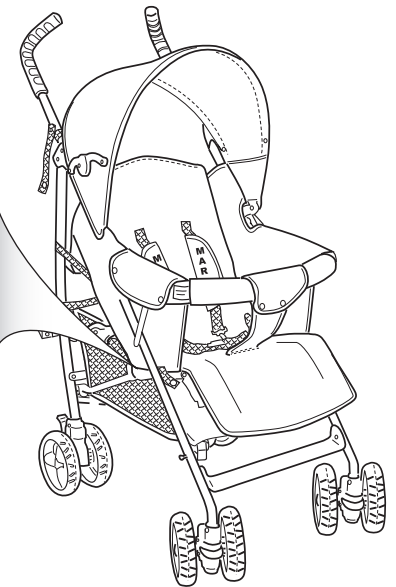

tested according to
EN 1888: 2003 + A1,A2,A3: 2005

IMPORTANT: Read these instructions carefully before use and keep them for future reference. Your child's safety may be affected if you do not follow these instructions.

MARKETING AND DISTRIBUTION
MARCO HANDELSGESELLSCHAFT M.B.H.
A-5440 GOLLING, AUSTRIA
www.marco4bb.com

© MARCO HANDELSGESELLSCHAFT M.B.H., 2008
A-5440-Golling, Austria